















Assembly Instructions

ITEM NO.: 55653

Thank you for purchasing this quality product. Be sure to check all packing material carefully for small parts that may have come loose inside the carton during shipment. (Note: Loosely thread all screws/bolts first. Once the item is assembled then completely tighten.)

TOOLS REQUIRED				HARDWARE LIST:				
PARTS LIST:				No.	Sketch	Description	Size	Quantity
No.	Description	Sketch	Quantity	J		Flat Washer	φ5/16" x 7/8"	8
A	Chair Back		1	K		Lock Washer	φ5/16"	8
B	Left Front leg		1	L		Bolt	φ5/16" x 2-1/4"	8
C	Right Front leg		1	M		Allen Wrench	φ5mm	1
D	Left Back leg		1	N		Screw	φ8 x 38mm	8
E	Right Back leg		1					
F	Front Connecting Rod		1					
G	Back Connecting Rod		1					
H	Left Connecting Rod		1					
I	Right Connecting Rod		1					

STEP 2

STEP 1

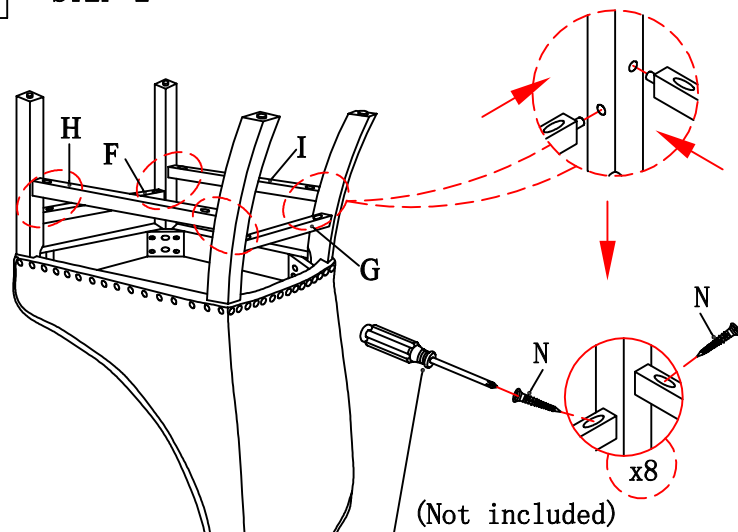
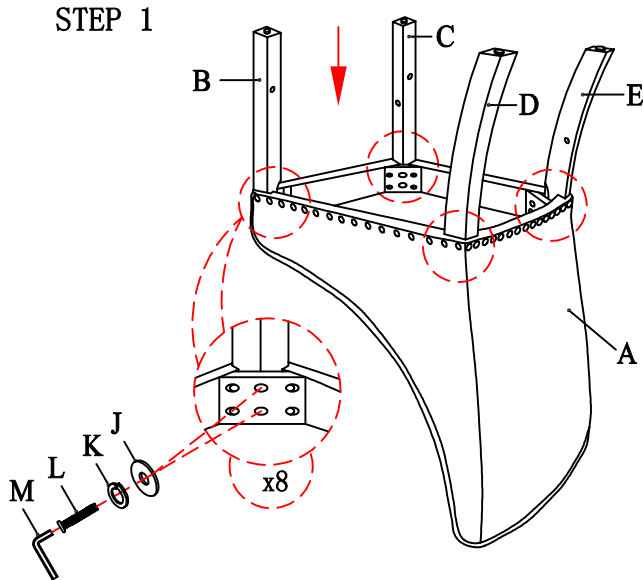

STEP 3

